





C&I ENERGY STORAGE SYSTEM

30kw ~ 50kw

112kWh

Designed for large residential communities, retail spaces, agricultural land, and small industrial applications.

-  A general application with Grid and PV
-  Application with Grid, PV and Generator
-  Working with existing PV inverters without Grid
-  Application for EV Charging Station



Easy Installation

- Cost-effective Installation: Plug and play pre-assembled simplifies on-site setup, saves time and labor.
- Diesel Generator Compatibility: Direct connection to generators without the need for an ATS box, offers flexible power configuration.

Efficient and Reliable

- Flexible Over-Config: Supports 200% PV over-configurations efficiently uses solar energy, ensures long-term system operation.
- Seamless Switching: Supports smooth switching between grid and off-grid, ensures continuous and stable power supply to key equipment.

Safe and Worry-Free

- Fire Protection: Optional AFCI to effectively prevent fire risks caused by arc faults, ensures system safety.
- Multi-layer Protection: Supports battery health alerts and multi-layer protection mechanisms, ensures safety and stability during operation.

Smart Management

- Intelligent Monitoring: 24/7 monitoring via APP and cloud platform, allows users to monitor equipment status in real-time, enables remote management.
- Intelligent Maintenance: Supports remote troubleshooting and maintenance, reduces on-site repair needs and labor costs, avoids expert visits.

Technical Data

MODEL	MECC-50/112
DC PARAMETERS	
MAX.PV ARRAY POWER	100 KWP
MAX.PV INPUT VOLTAGE	1000V
NOMINAL INPUT VOLTAGE	600V
MPPT VOLTAGE RANGE	150-850 V
MAX.PV CURRENT	40A/40A/40A/40A
MAX.SHORT CIRCUIT CURRENT	60A/60A/60A/60A
NO.OF MPPTS/STRINGS PER MPPT	4/2
AC PARAMETERS	
RATED OUTPUT POWER	50 KW
MAX.APPARENT POWER	50KVA
NOMINAL AC VOLTAGE	3W+N+PE, 220V/380V 230V/400V
NOMINAL AC FREQUENCY	50HZ/60 HZ
RATED OUTPUT CURRENT	76 A
MAX.OUTPUT CURRENT	76 A
ADJUSTABLE POWER FACTOR RANGE	>0.99 (0.8 LAGGING TO 0.8 LEADING)
PEAK OUTPUT APPARENT POWER(2S)	80 KVA
THDI(RATED POWER)	<2%
BATTERY PARAMETERS	
BATTERY TYPE	LIFEPO4
RATED CAPACITY	314 AH
RATED BATTERY VOLTAGE	358.4V
RATED ENERGY	112 KWH
MAX.CHARGING/DISCHARGING CURRENT	157A
SYSTEM PARAMETERS	
DEPTH OF DISCHARGE	90%
OPERATING TEMPERATURE	-25°C TO +55°C
OPERATING HUMIDITY	0%-95%(NON-CONDENSATION)
OPERATING ALTITUDE	2000M
COMMUNICATION	RS485/WI-FI/ETHERNET/CAN
TEMPERATURE CONTROL MODE	SMART AIR COOLING
NOISE	<70DB
INGRESS PROTECTION	CABINET:IP55;INVERTER:IP66
DIMENSION(W*H*D)	≤1000*2100*1100 MM
WEIGHT	≤1500 KG

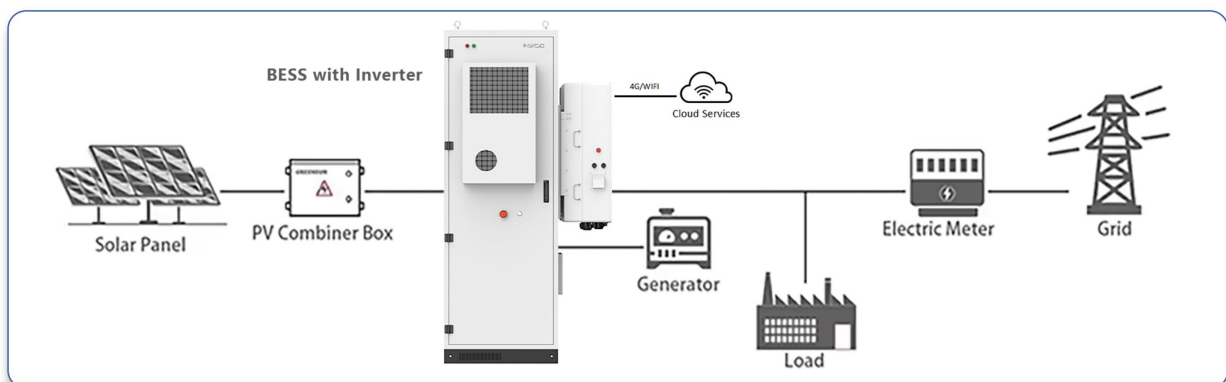

A general application with Grid and PV

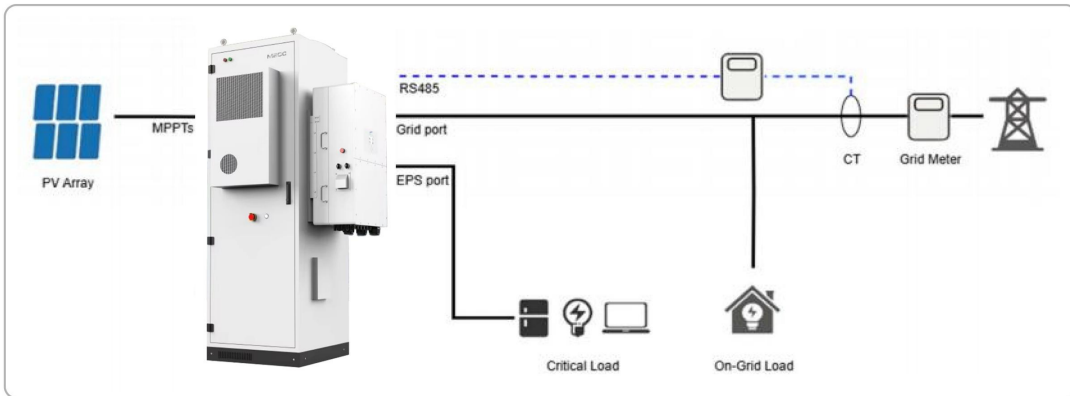

Application with Grid, PV and Generator

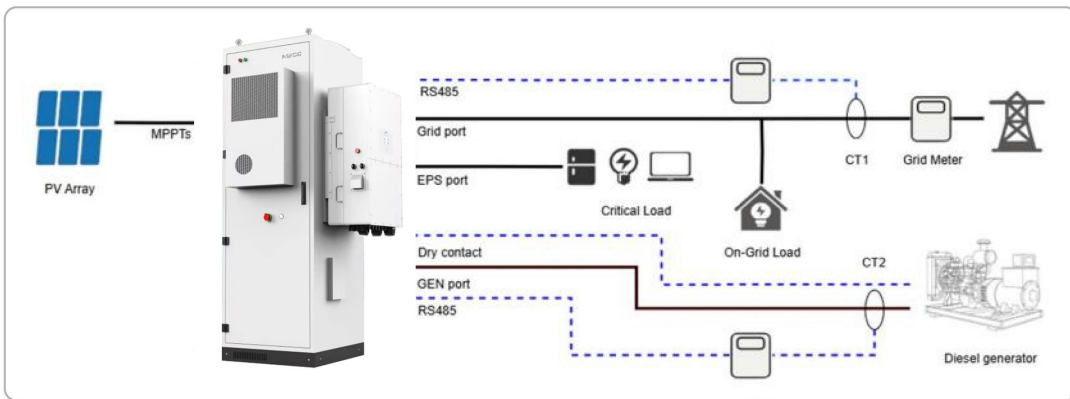

Working with existing PV inverters without Grid

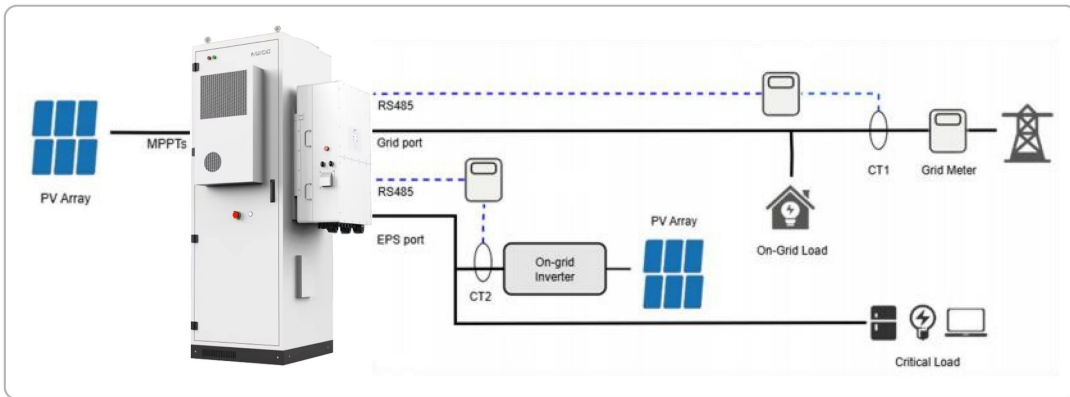

Application for EV Charging Station

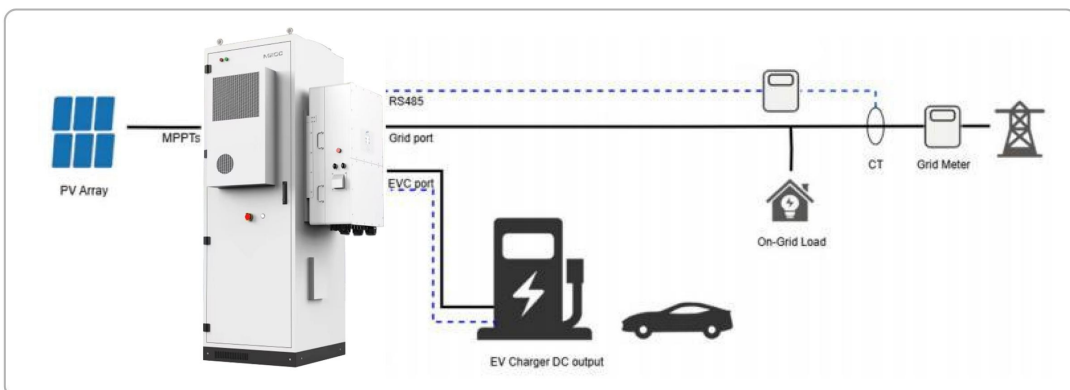

Product features



- Air conditioner**
Cooling the BESS.
- Smoke detector**
A device used to detect smoke in a fire and sound an alarm when smoke is detected.
- Manual service disconnect**
In order to protect the safety of technicians servicing in high voltage environments or respond to sudden events, the connection of the high voltage circuit can be quickly separated.
- Travel switch**
When the BESS is detected to be on fire, aerosol is emitted to extinguish the fire. Check whether the BESS's door is closed.
- Aerosol fire's suppression device**
When the BESS is detected to be on fire, aerosol is emitted to extinguish the fire.
- Fire suppression water pipe**
Fire suppression and cooling.
- Heat detector**
A device used to measure temperature and sound an alarm if it detects excessive temperature.

Safety and Protection

- Advanced aerosol fire suppression system for enhanced safety
- Combustible gas, smoke, and temperature detection with active exhaust and fire alarm
- IP55-rated enclosure for protection against dust and water ingress
- CE, IEC62619, IEC62040, and UN38.3 certified for quality and safety

IP55 protection, can be used normally in outdoor, rainy weather and other scenarios

Performance & Durability

- Wide operating temperature range: 0-55°C for charging and -20-55°C for discharging
- Long cycle life: > 6000 cycles at 90% DOD, 0.5C charge/discharge, and 25 ± 2°C
- 10-year warranty for peace of mind
- Suitable for high-rate cyclic charging and discharging scenarios

Applications & Scalability

- Ideal for various applications, including off-grid operation, power supply redundancy, and black start function
- Expandable up to 50 kW / 360 kWh for single systems and 500 kW / 1.12MWh for parallel systems
- AC side of the inverter can be paralleled with up to ten machines for larger installations



UN 38.3 MSDS

System Components



Energy storage battery

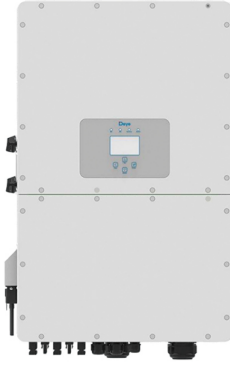

Inverter



Product Expansion

30KW-50KW Inverter selectable



Smart APP + EMS

Display the data details of the current device, and view the battery charging and discharging power, and charging and discharging time data separately, and support time filtering

One-tap Support

Visible Energy Earnings